



SETUP GUIDE



SETUP GUIDE

Model Mini 3i

Notes, Cautions, and Warnings



NOTE: A NOTE indicates important information that helps you make better use of your smartphone.



CAUTION: A CAUTION indicates either potential damage to hardware or loss of data and tells you how to avoid the problem.



WARNING: A WARNING indicates a potential for property damage, personal injury, or death.

Information in this document is subject to change without notice.

© 2009 Dell Inc. All rights reserved.

Reproduction of these materials in any manner whatsoever without the written permission of Dell Inc. is strictly forbidden.

Trademarks used in this text: *Dell* and the *DELL* logo are trademarks of Dell Inc.; *Bluetooth* is a registered trademark owned by Bluetooth SIG, Inc. and is used by Dell under license.

Other trademarks and trade names may be used in this document to refer to either the entities claiming the marks and names or their products. Dell Inc. disclaims any proprietary interest in trademarks and trade names other than its own.

Designs, images, and other depictions of products may change from when this publication was produced.

Contents

Setting Up Your Mini 3i Smartphone	5	Making Calls.	16
Check the Package Contents	5	Answering or Declining Calls.	16
Activate Phone Service.	6	Checking Voicemail	17
Set Up the Phone	6	Using Messaging Features.	17
Mini 3i Smartphone Features	10	Managing Bluetooth Connections	18
Front View.	10	Using the Internet Browser	18
Back View.	10	Using Email Features.	19
Left View.	11	Using the Camera	19
Right View.	12	Accessing and Using Other Applications	20
Using Your Mini 3i Smartphone	13	Mini 3i Smartphone Accessories	21
Switching Between Screens	13		
Status Bar.	14		

Setting Up Your Mini 3i Smartphone

Congratulations on your purchase of the Dell™ Mini 3i advanced smartphone. This section provides information to setup and start using your smartphone.

Check the Package Contents

Check the contents of your phone packaging to verify that you have the following:

- Phone
- MicroSD (pre-installed with navigation map, PC Sync tool, and *User's Manual*)
- Battery
- Power adapter (with one regional plug head)
- Pouch
- Stylus
- USB to Mini-USB cable
- Mini-USB stereo headset

- Mini-USB to 3.5 mm audio adapter (may ship depending on the choice you made during purchase)

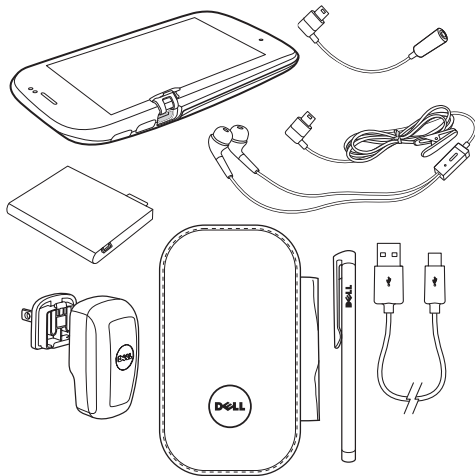

Setting Up Your Mini 3i Smartphone

To use all of the phone features, you need:

- A wireless service plan with a carrier
- An Internet connection
- A computer with a USB 2.0 port

Activate Phone Service

Before you can use any of the phone features, you must activate the phone. To activate the phone you must:

- Sign up for a service plan with a service carrier in your area
- Register the phone with the network

If you purchased this phone from a service carrier, activation may have been done during the purchase.

Set Up the Phone

You must install the battery, SIM card, and charge the battery before you can use your smartphone.

To set up your phone for the first time:

1. Open the cover.

Slide a finger into the finger slot, then lift the cover.

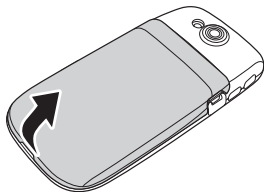

2. Install the SIM card.

- a. Rotate the SIM card lock outwards.

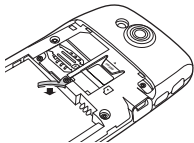

- b. Hold the SIM card with the metal contacts facing down and insert the card into the SIM card holder.

 **NOTE:** To ensure proper installation, align the cut corners in the card and the SIM card slot.

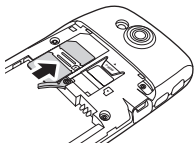

- c. Rotate the SIM card lock back into place to lock the SIM card.

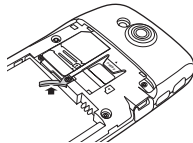

3. Install the microSD card.

- a. Hold the microSD card with the metal contacts facing down.
- b. Slide the microSD card into the microSD card holder.

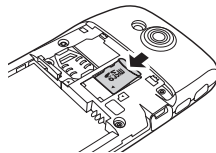

Setting Up Your Mini 3i Smartphone

4. Install the battery.

Align the metal contacts on the battery with the contacts on the battery holder and insert the battery.

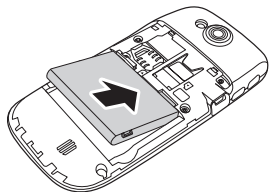

5. Close the cover.

Insert the tabs on the cover into the slots on the phone and snap the cover in place.

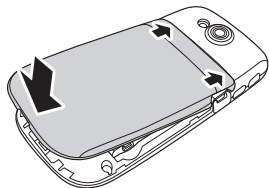

6. Charge the battery.



CAUTION: Do not use any non-approved chargers as they may damage your phone and invalidate any warranties.



NOTE: It takes at least one charging-discharging cycle for the battery to reach its peak performance.

- a. Using the Mini-USB to USB cable, plug the power adapter into a power outlet and then into your phone.

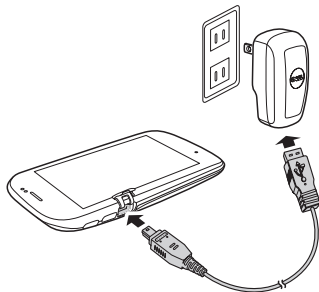

- b. Charge your phone for at least 2 hours. Ensure that your phone is fully charged by checking the charge indicator on the status bar.

7. Turn on your phone.

Press and hold the power button for two seconds.

Mini 3i Smartphone Features

Front View

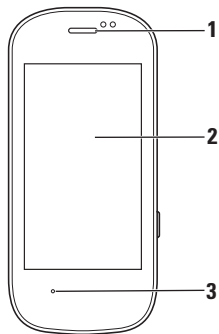

- 1 Speaker** — Use to listen to phone conversations.
- 2 Touch screen** — Displays phone images.
- 3 Microphone** — Use for voice calls.

Back View

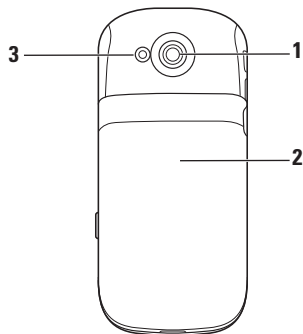

- 1 Camera** — Use to take photos and capture video.
- 2 Cover** — Covers the battery, SIM card, and microSD card holders.
- 3 Camera flash** — Use to take photos in dim light.

Left View

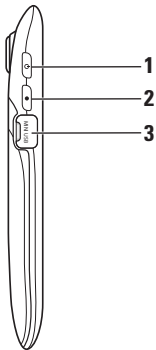

1 Power/Lock button — Short press (when the display is active): locks or unlocks the display.

Short press (when the display is in sleep mode): wakes up the display.

Long press: Power On/Power Off.

2 Home/Back button — Short press: navigate back one screen at a time.
Long press: return to the Home screen.

3 Mini-USB port — Use to charge the phone, connect to a computer, or connect to a headset.

Right View

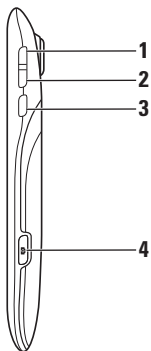

- 1 Volume up** — Press to increase the volume level.
- 2 Volume down** — Press to decrease the volume level.
- 3 Options button** — Short press to open the Options menu.
- 4 Camera button** — Press to activate the camera and take photos or capture video.

Using Your Mini 3i Smartphone

This section describes the fastest way to access tools and features on your smartphone.

 **NOTE:** For more information on other options for the tasks described in this section, see the *User's Manual* on the Dell Support website at supportaj.dell.com.

Switching Between Screens

Your phone can hold many different applications and shortcuts. In order to make these items easily accessible, you can have multiple screens that display up to 24 icons at a time.

To switch between the screens, swipe your finger or the optional stylus across the screen from left to right, or right to left.









Status Bar





















The status bar appears at the top of the screen. Icons appear on the status bar to notify you of a new message, upcoming calendar event, alarm, or other information important to you.

To learn more about these icons and the features they indicate, see the *User's Manual* on the Dell Support website at supportapj.dell.com.

The following table outlines status icons:



Icon	Information
	New email
	New SMS or MMS
	New instant message
	New voicemail
	Alarm is set
	GPS is enabled
	GPS is connected
	Sync
	Sync error

Icon	Information	Icon	Information
	Outgoing call		Bluetooth is connected
	Missed call		Bluetooth is enabled
	Incoming call		Battery charge is full
	Call forwarding is active		Battery charge is 20%
	Speakerphone is on		Battery is charging
	Microphone is on mute		Full signal strength
	Silent mode		Half signal strength
	Vibrate mode		No signal
	USB is connected		microSD card is installed

Making Calls

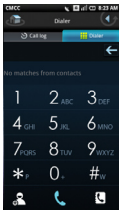
1. Tap the **Dialer** icon  on the Home screen.
2. Tap the **Dialer** tab at the top of the dialer screen to open the on-screen dial pad.



3. Tap the on-screen dial pad to enter a number and press  to call. To make corrections tap .

 **NOTE:** For more information on other options for this task, see the *User's Manual* on the Dell Support website at supportapj.dell.com.

Answering or Declining Calls

- Slide the notification bar to the top to answer a call.
- Slide the notification bar down to decline the call and direct the call to your voicemail.

 **NOTE:** For more information on other options for this task, see the *User's Manual* on the Dell Support website at supportapj.dell.com.

Checking Voicemail

The voicemail icon appears on the status bar if you miss or decline a call or if someone leaves a voice message.

1. Tap  on the status bar.
The list of voicemail messages that you have for your account is displayed on the screen.
2. Tap the listing for the message that you want to hear.

 **NOTE:** For more information on other options for this task, see the *User's Manual* on the Dell Support website at supportaj.dell.com.

Using Messaging Features

You can use the messaging feature to send and receive messages.

1. Tap the **Messaging** icon .
2. Press the **Options** button to display a short menu on the bottom of the screen.

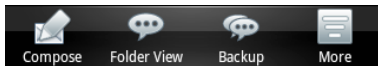

3. Using the short menu, you can compose a new message, change your view to a list (default) or folder view (like an email program) and backup your messages. To change the message service settings, tap **More**.

Managing Bluetooth Connections

You can connect your phone to headsets, printers, and networks using Bluetooth® technology.

1. Tap the **Settings** icon  and select **Bluetooth settings**.
2. If the **Bluetooth** check box is not selected, tap it to enable bluetooth connections.
3. In the Bluetooth devices list, tap the name of the device you want to pair with the phone and follow the instructions that appear on the screen.

Using the Internet Browser

You can access standard and optimized mobile websites by using the integrated web browser.

1. Tap the **Browser** icon  to open the Internet browser.
2. Press the **Options** button and select **Go**.

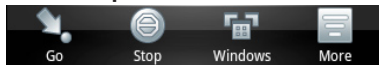

3. Enter either a search phrase to search for sites online, or enter the URL for the site you wish to access, in the address bar.

Using Email Features

You can use the Email feature to send and receive messages.

1. Tap the **Messaging** icon .
2. Press the **Options** button to display a short menu on the bottom of the screen.

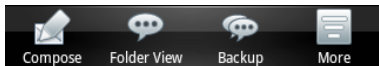

3. Using the short menu, you can compose a new message, change your view to a list (default) or folder view (like an email program) and backup your messages. To change the message service settings, tap **More**.



Using the Camera

You can capture video and still images using the camera.

 **NOTE:** You must have a microSD card with enough free space to store images and videos captured using the camera.

1. Tap the **Camera** icon  or press the camera button.

The camera application displays the available options: flash mode, video or still mode, light balance, and picture depth.

2. Select either still image  or video  mode.
3. Tap the screen or press the camera button to capture an image or start recording video.

Accessing and Using Other Applications

In addition to the applications that ship with your phone for communication, productivity, and entertainment, you can download applications from the online sources provided by your service carrier, or from other sources on the Internet.

Regardless of the applications you plan to use, there are a few short steps and tips that apply to all applications:

- To browse and select an application to use, you must access the Home screen. If your phone is in a sleep or hibernate mode with an active screensaver, tap and hold the moving circle, and drag it to the gray circle at the bottom of the screen.
- To open a program, tap an icon once.

- To view all of the application and shortcut icons on your screen, you may need to swipe your finger across the screen in a rapid motion to move the focus from right to left, and so forth.
- To move or delete an icon, press and hold the icon, and follow the instructions on the screen.

 **NOTE:** Icons of certain applications may be locked in position by the service carrier.

- To add an application or shortcut, press and hold an empty space on the Home screen and follow the instructions that appear on the screen.
 - To protect your applications, settings, and data, it is recommended that you back up the information regularly to a microSD card.
-  **NOTE:** For information on backing up data, see the *User's Manual* on the Dell Support website at supportaj.dell.com.

Mini 3i Smartphone Accessories

Your smartphone may ship with the following accessories:

- Mini-USB headset — Allows you to listen to music or a phone conversation. Callers hear you through the integrated microphone. To use the headset, connect it to the Mini-USB port.
- Stylus — Allows you to quickly enter text using the on-screen keyboard and handwriting tools.
- USB to Mini-USB data cable — Allows you to connect your smartphone to a computer for file transfers and data synchronization.
- Mini-USB to 3.5 mm audio adapter (optional) — Allows you to use headphones or headsets that use 3.5 mm connectors.
- Microfiber pouch — Allows you to store the phone for protection when not in use, and to clean the screen as needed.



CAUTION: Do not use solvents, water, or other liquids to clean your smartphone. The included pouch is designed to be used dry. Liquids may damage your smartphone and invalidate any warranties.

Printed in China.

Printed on recycled paper.

www.dell.com | support.dell.com



03H48YA01